

THIS COPY IS PROVIDED ON A RESTRICTED BASIS AND IS NOT TO BE USED IN ANY WAY DETRIMENTAL TO THE INTERESTS OF PANDUIT CORP.

Material	High Conductivity Seamless Copper Tube
Plating	Electro-Tin
Wire Size	300 STR/FLEX
Wire Type	Stranded Copper: Class G, H, I, K, M, Locomotive
Wire Strip Length	1-1/4 in.
Stud Size	3/8 in.
UL Listed Wire Connector	Yes, for applications up to 35kv. Consult cable manufacturer for voltage stress relief instructions with applications greater than 2000 volts.
UL Temperature Rating	90° C
C.S.A Certified Wire Connector	Yes
Panduit Color Code on Barrel	RED
Panduit Die Index No. on Barrel	P71
Alternate Industry Die Index No. () on Barrel	(18)



CERTIFIED



LISTED Wire Connector

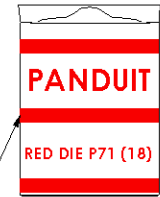
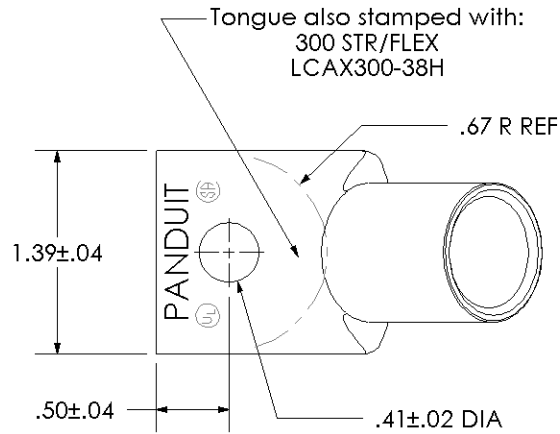

Color coded barrel markings

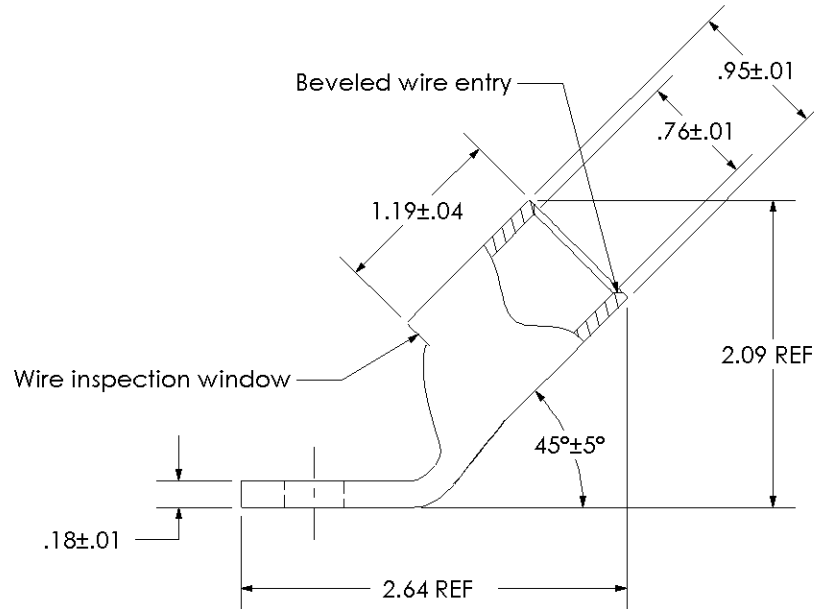

PANDUIT CORP. TINLEY PARK, ILLINOIS

LCAX300-38H-6
Copper Lug - One-Hole, Standard Flex Barrel, 45° Angle Tongue

00 6/03 CJW SAC

RELEASED

10850

REV DATE BY CHK

DESCRIPTION

ECN

SCALE N/A

DRAWING NO / CAD FILE

LCAX300-38H-CUST